

2018

Rally Plaques

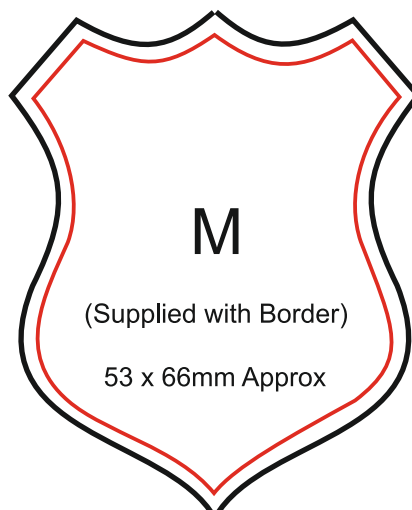

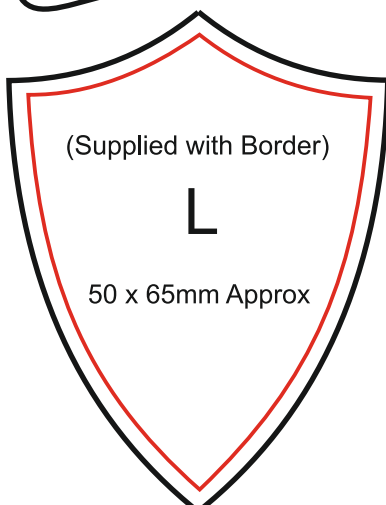

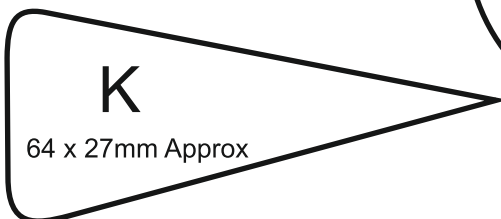
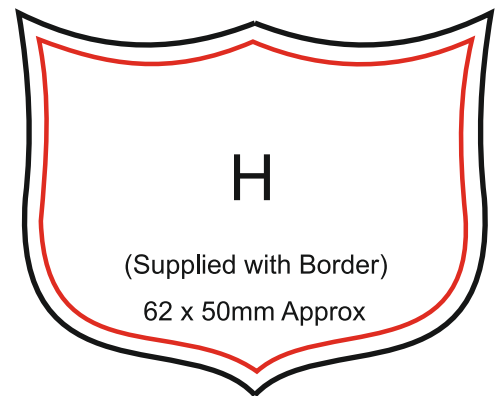
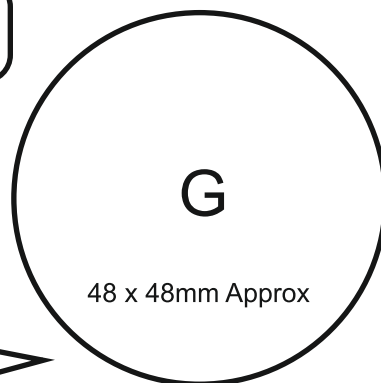
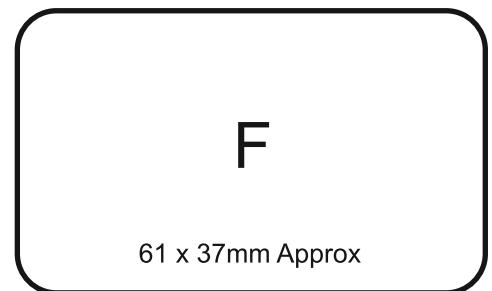
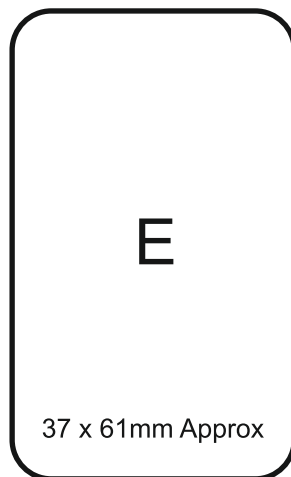
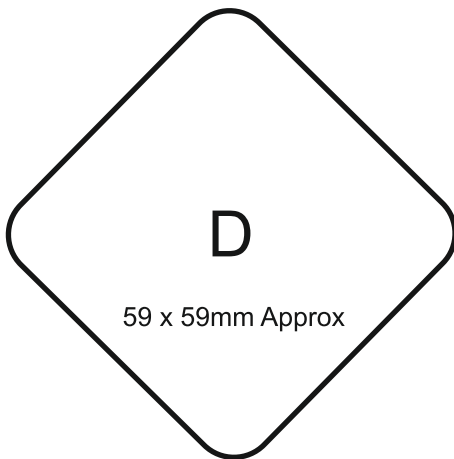
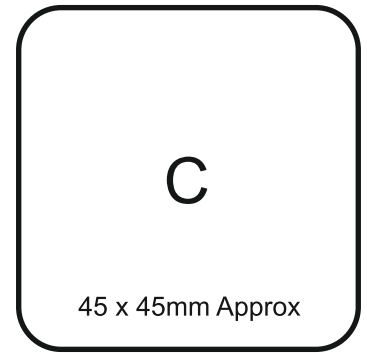
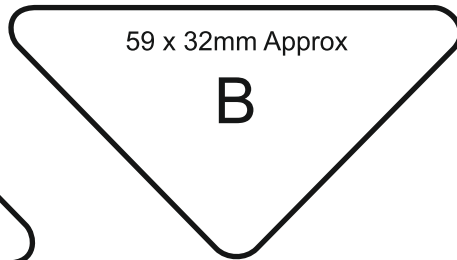
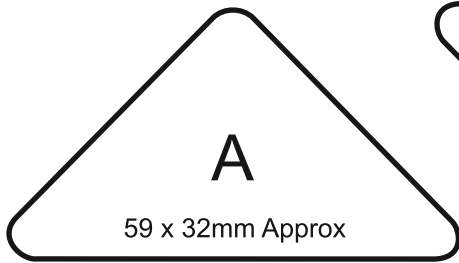
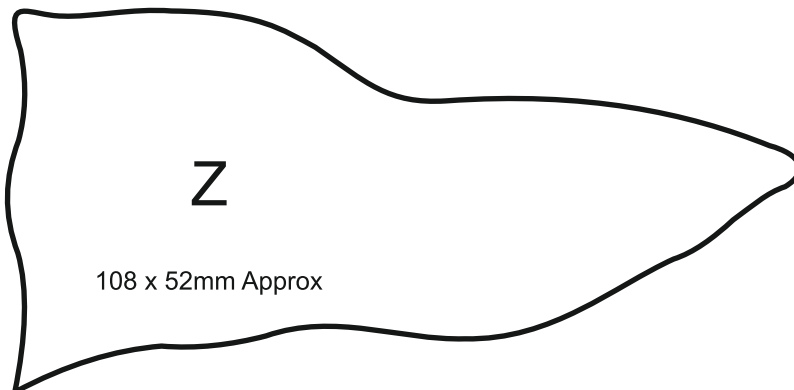
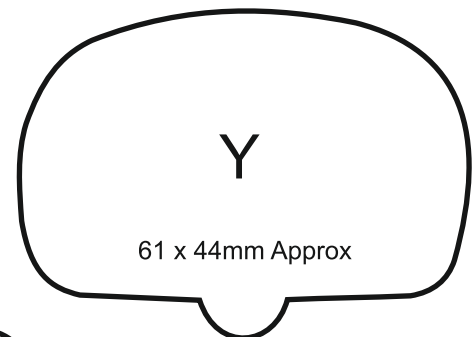
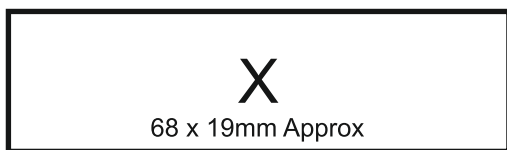
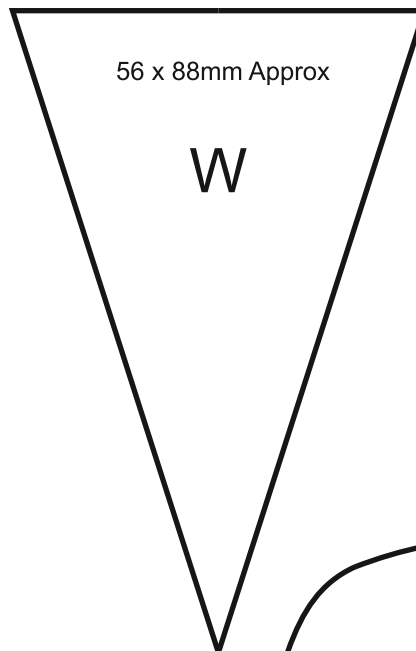
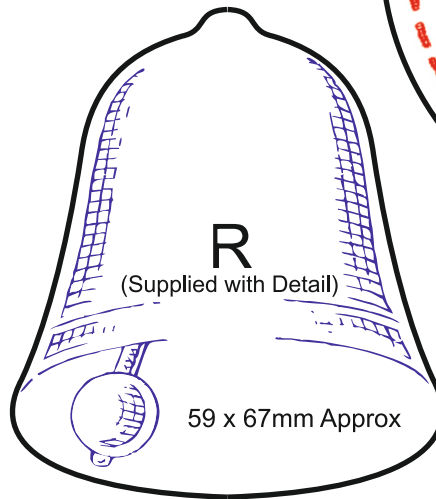
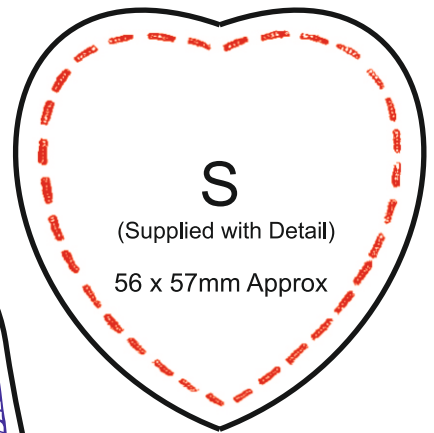
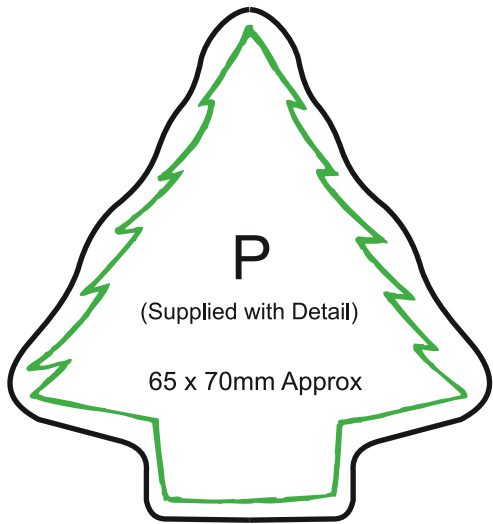
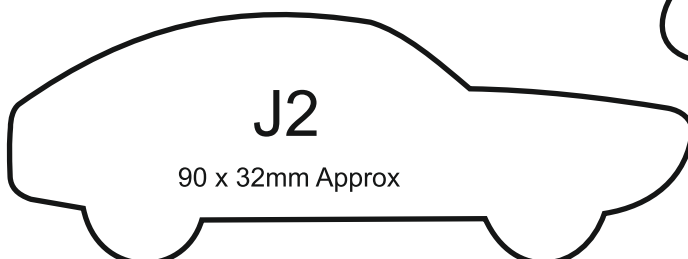
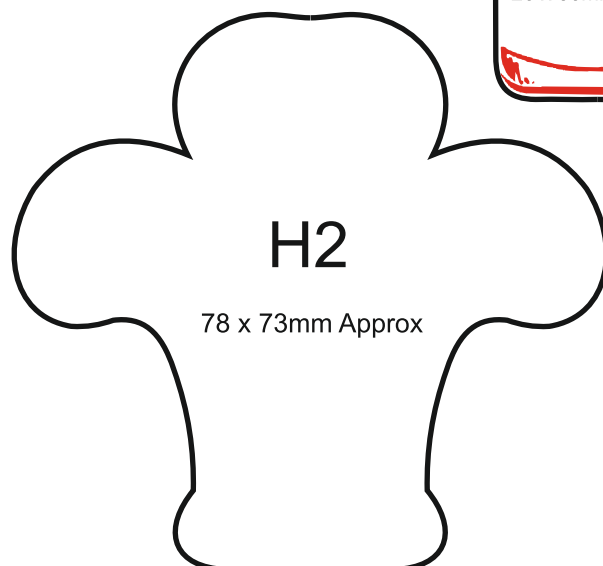
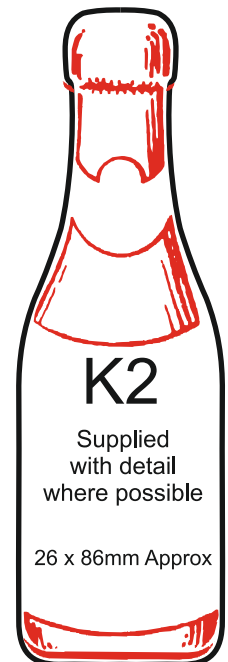
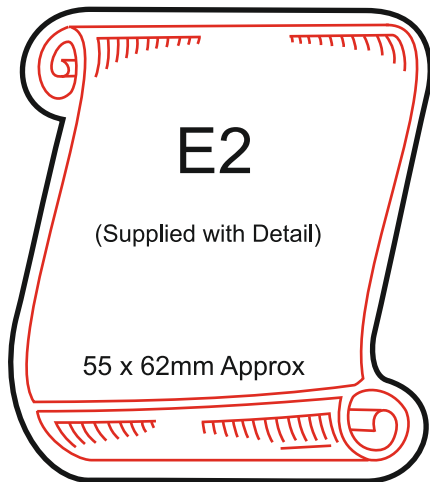
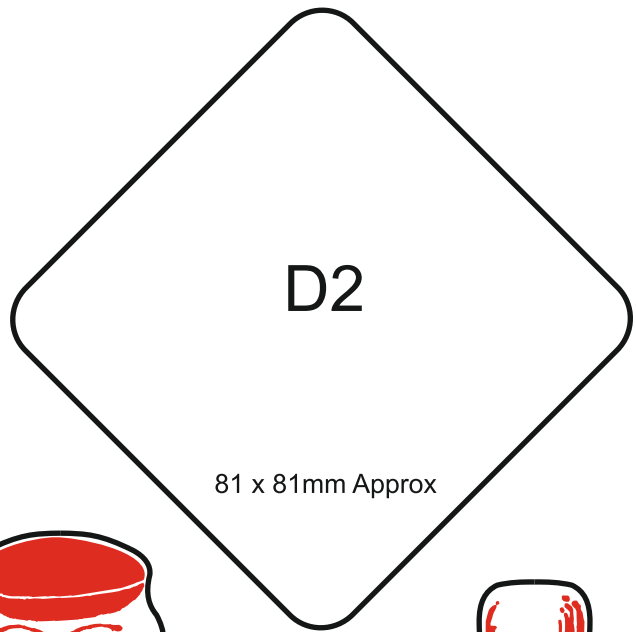
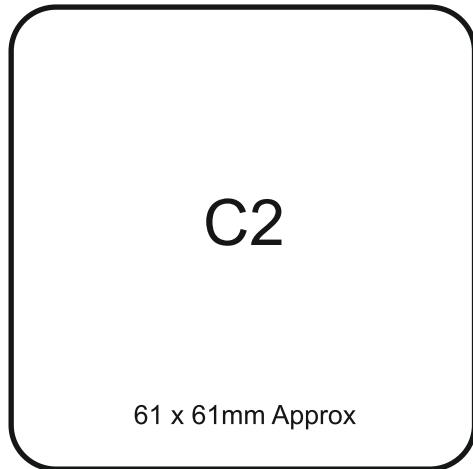

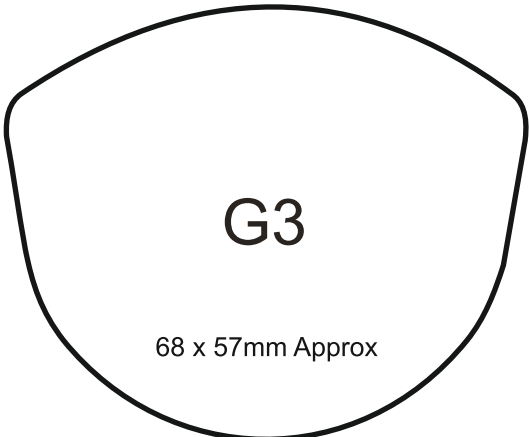
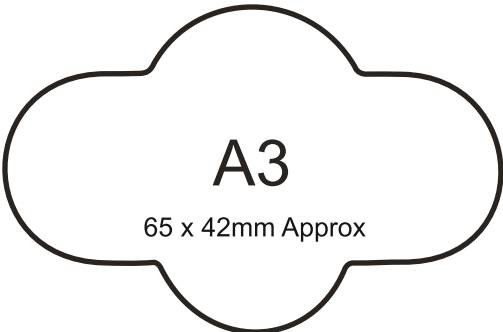
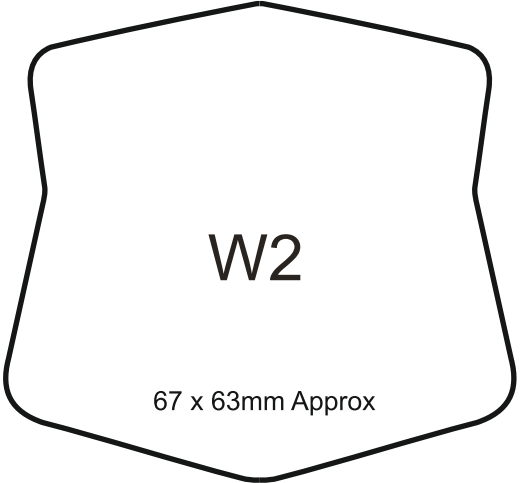
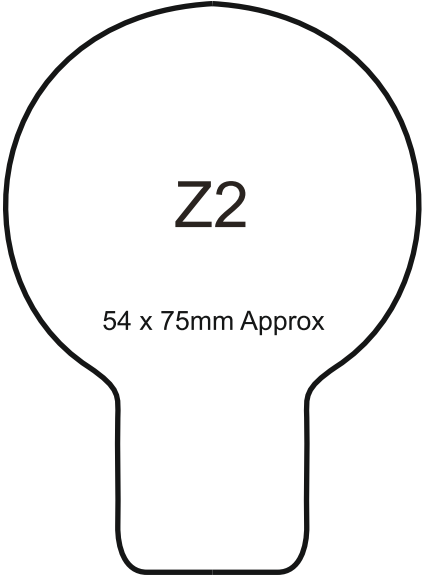
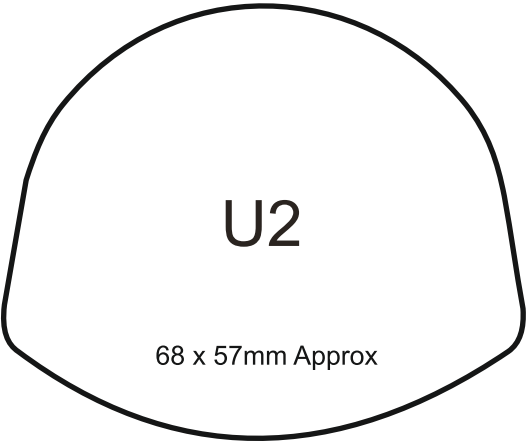
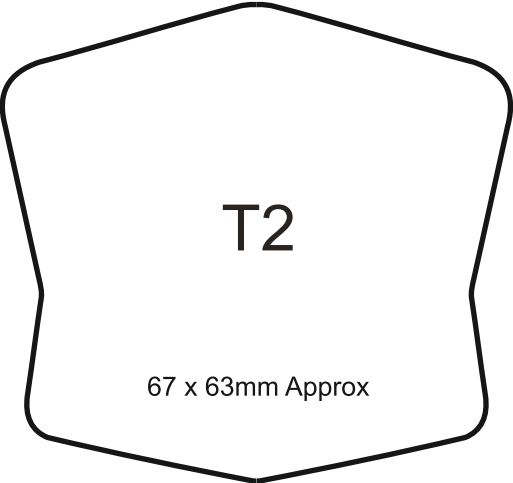
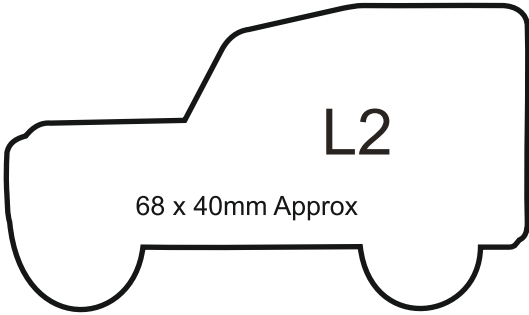
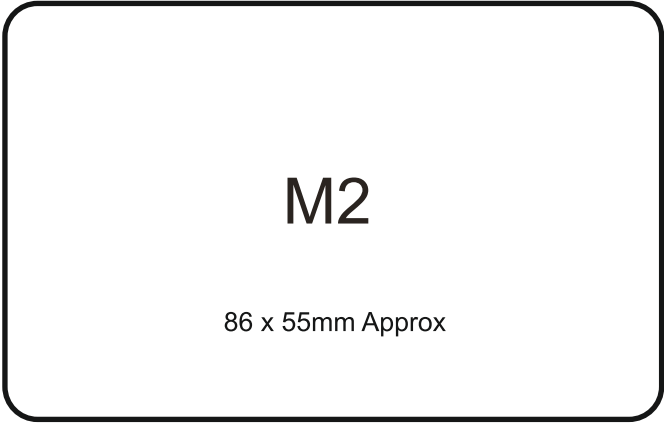

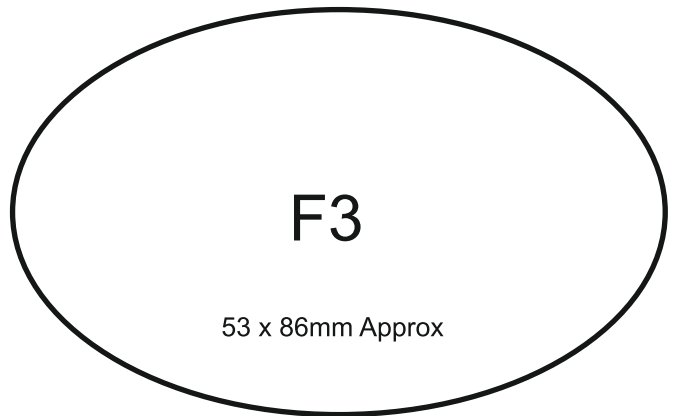
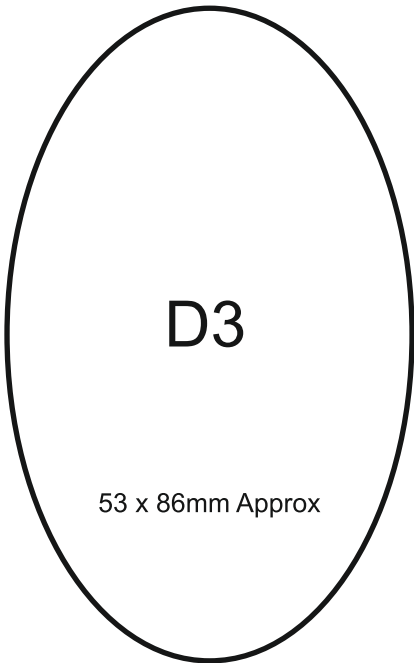
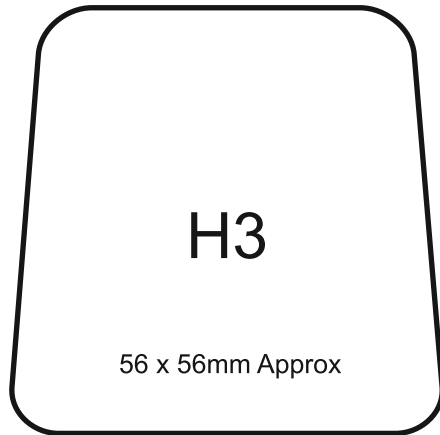
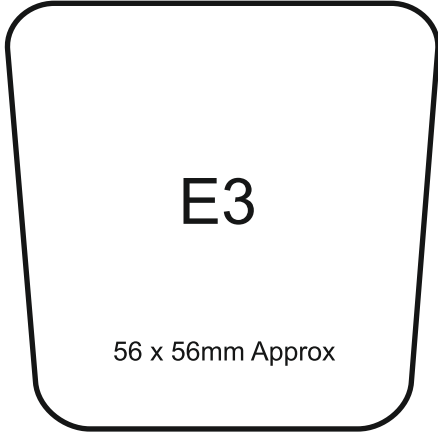
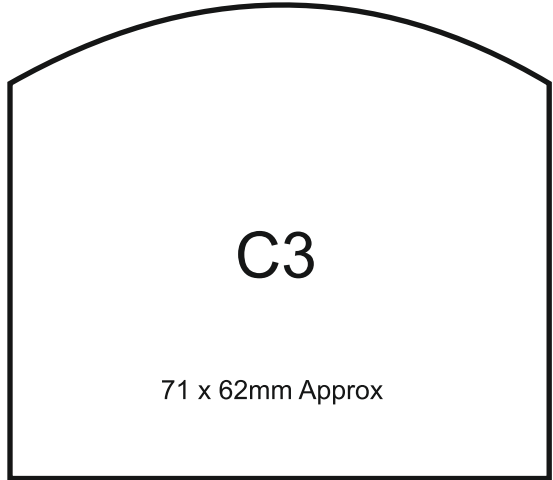

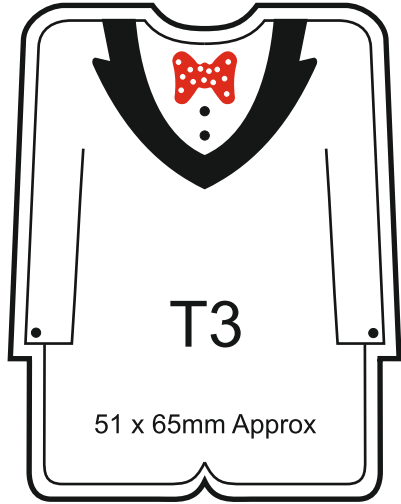
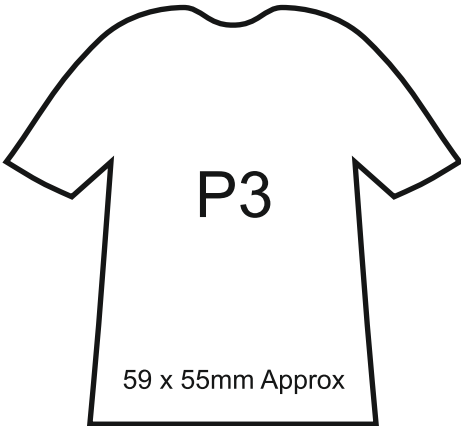
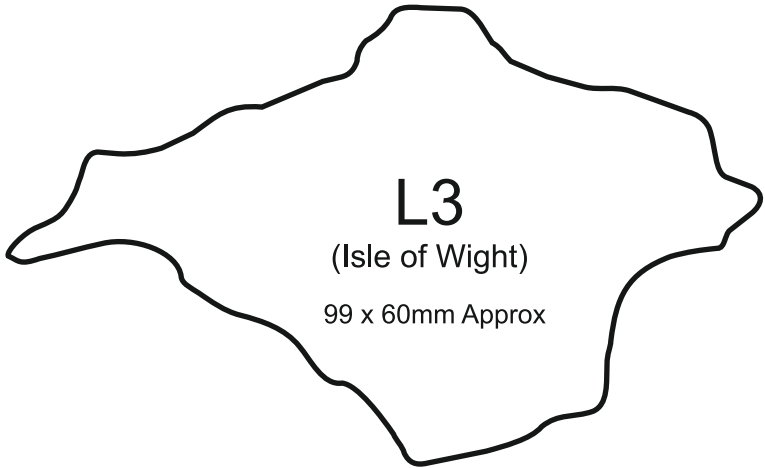
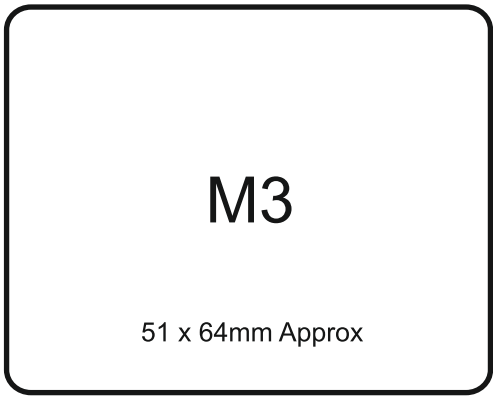
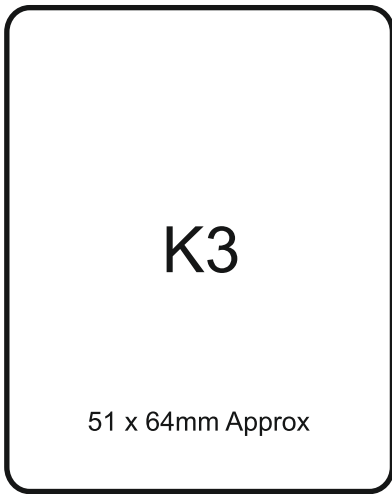
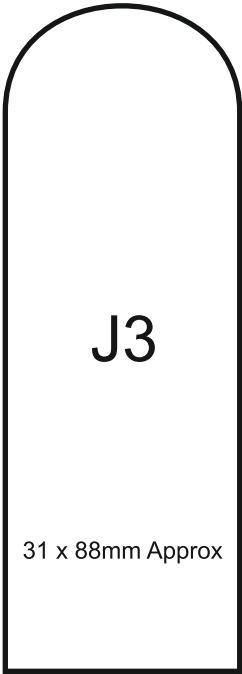

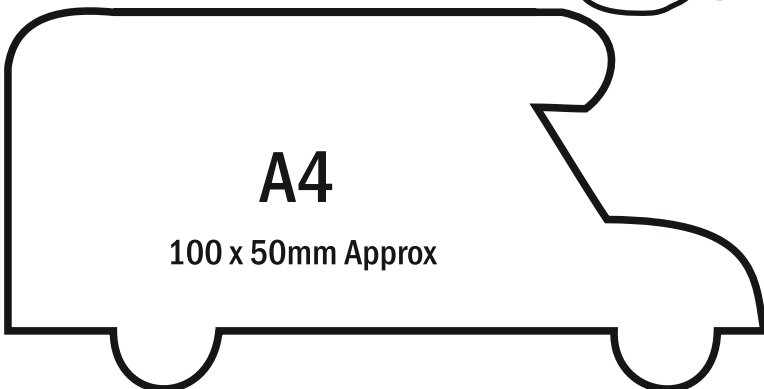
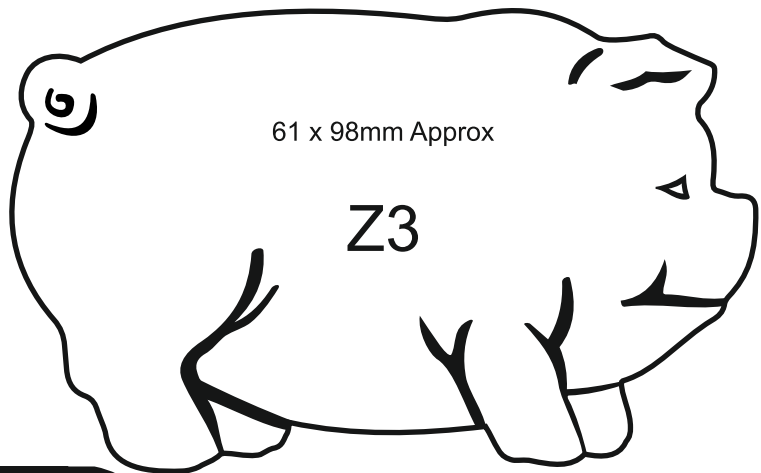
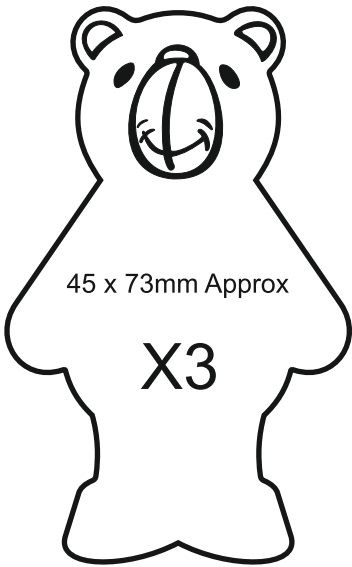
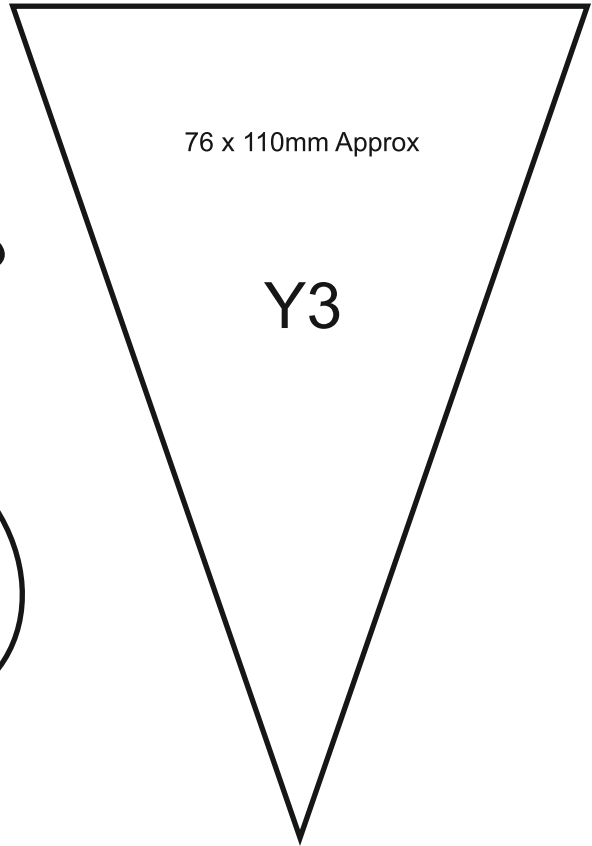
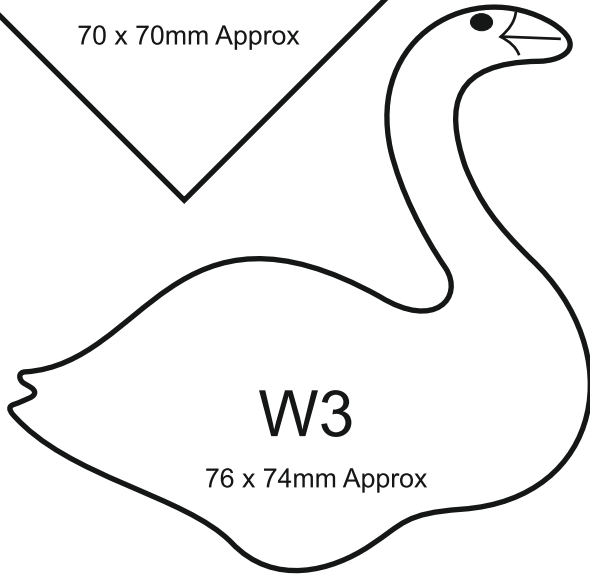
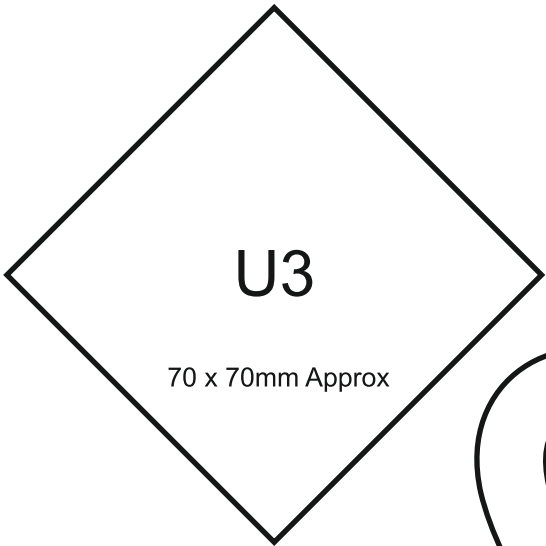

**Unit 1, Red Lane Mill
Sunny Bank Mills
Town Street, Farsley
West Yorkshire
LS28 5UJ**

Tel/Fax 0113 204 0242

Email: sales@wharfedaleandbowies.co.uk

www.wharfedaleandbowies.co.uk